

RED RIVER ARENAS.com

“Spend Less, Get More!”

800-343-1026

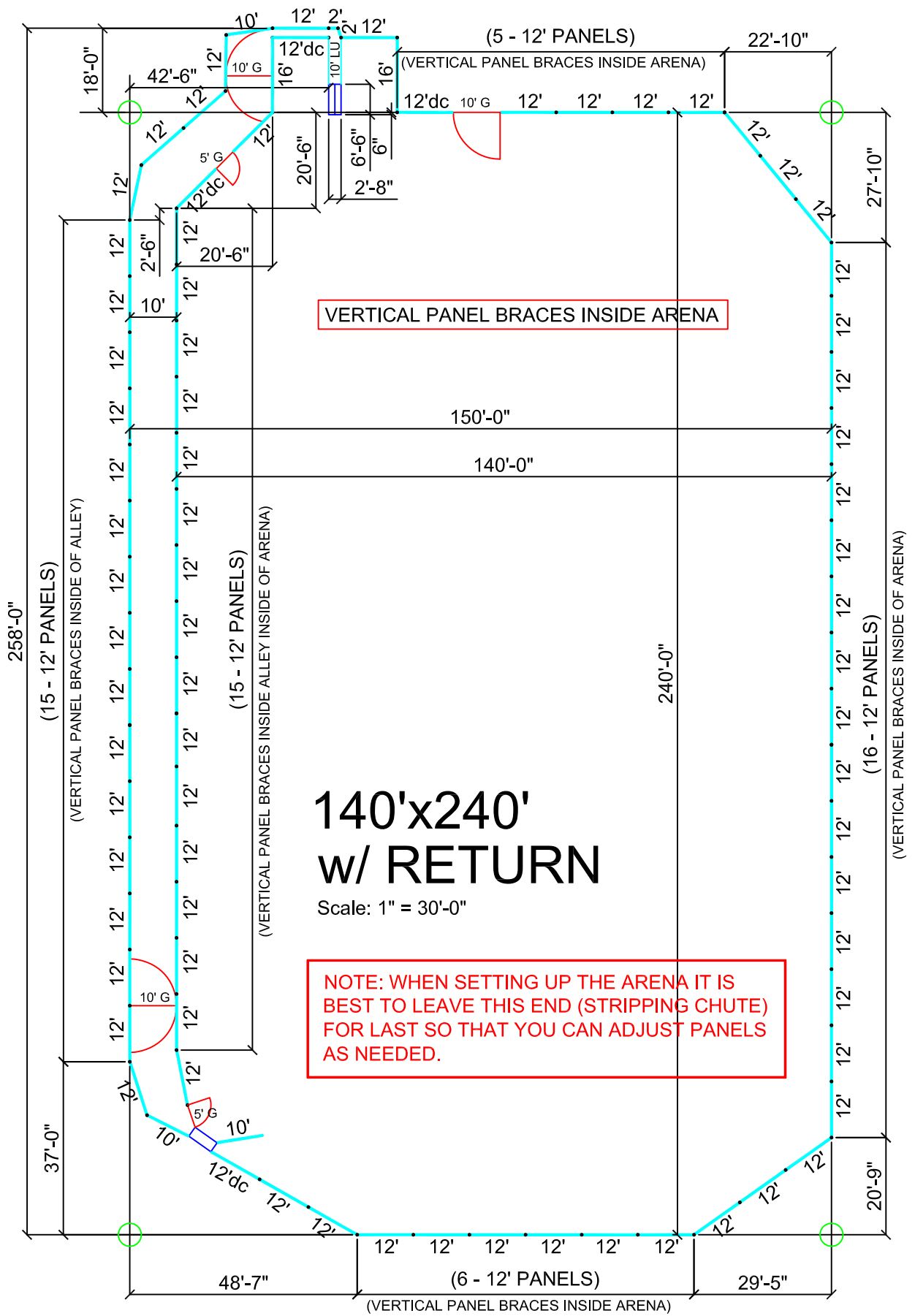

140 X 240 W/ RETURN EXCAVATION AREA

MINIMUM EXCAVATION AREA IS 150'-0" BY 258'-0"

- 1 Start by staking out the Arena Area (140'-0" by 240'-0") to use as a guideline for panels.

NOTE: IF EXCAVATION EXCEEDS THE GIVEN DIMENSIONS OWNER
WILL NEED TO COMPENSATE ACCORDINGLY

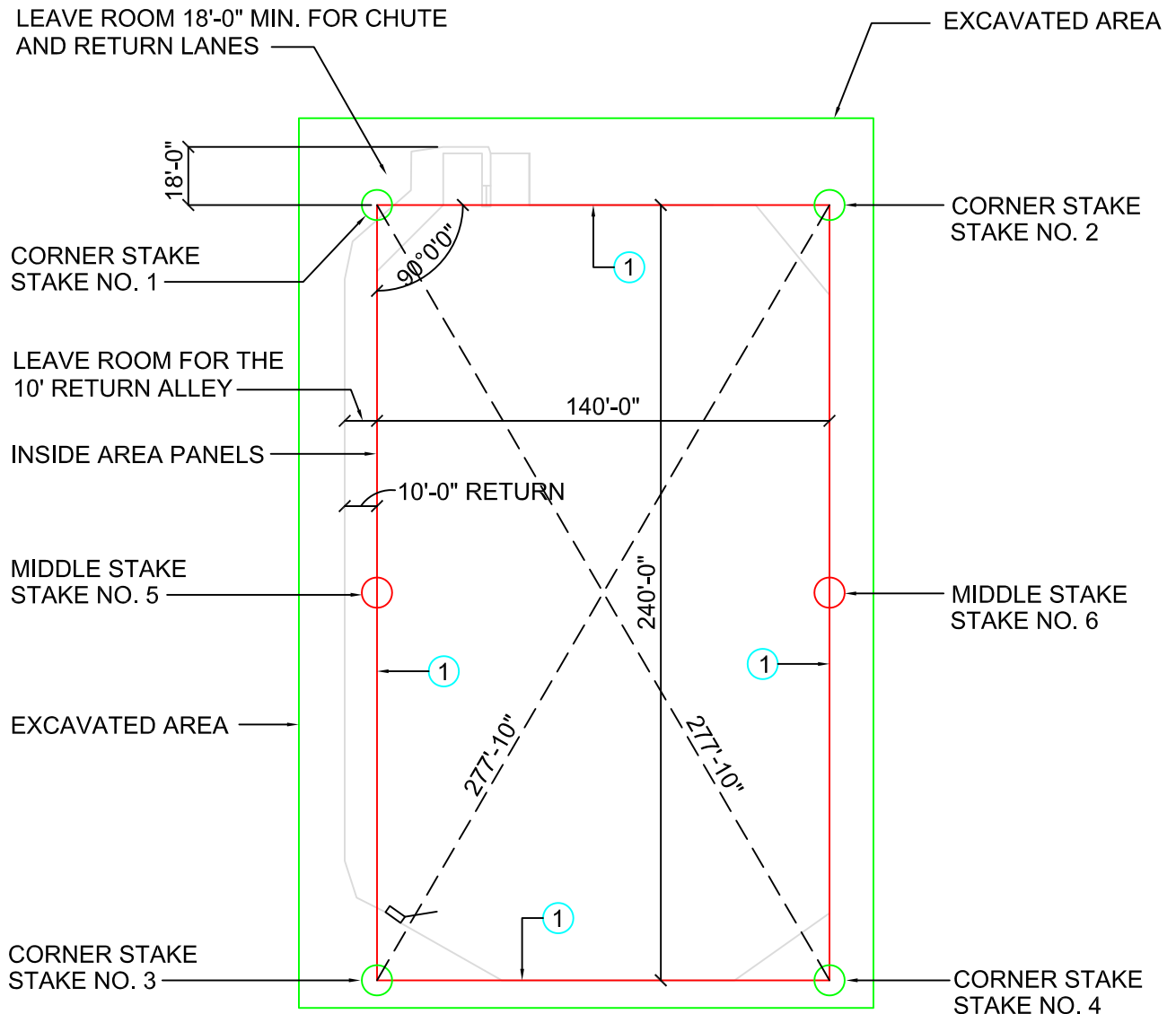

140 X 240 w/ RETURN ROPING CHUTE LOCATION

② Position the BACK Corner (A) of the Roping Chute at the dimension shown below:

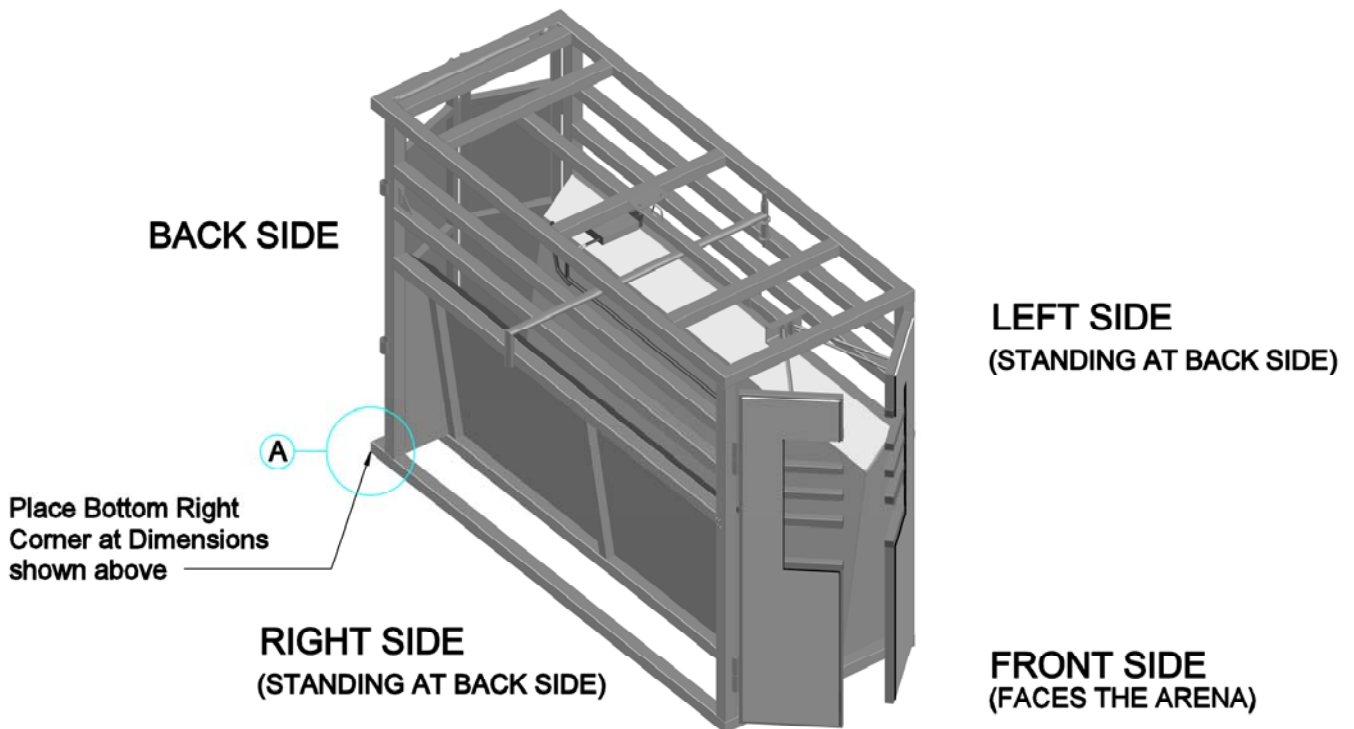
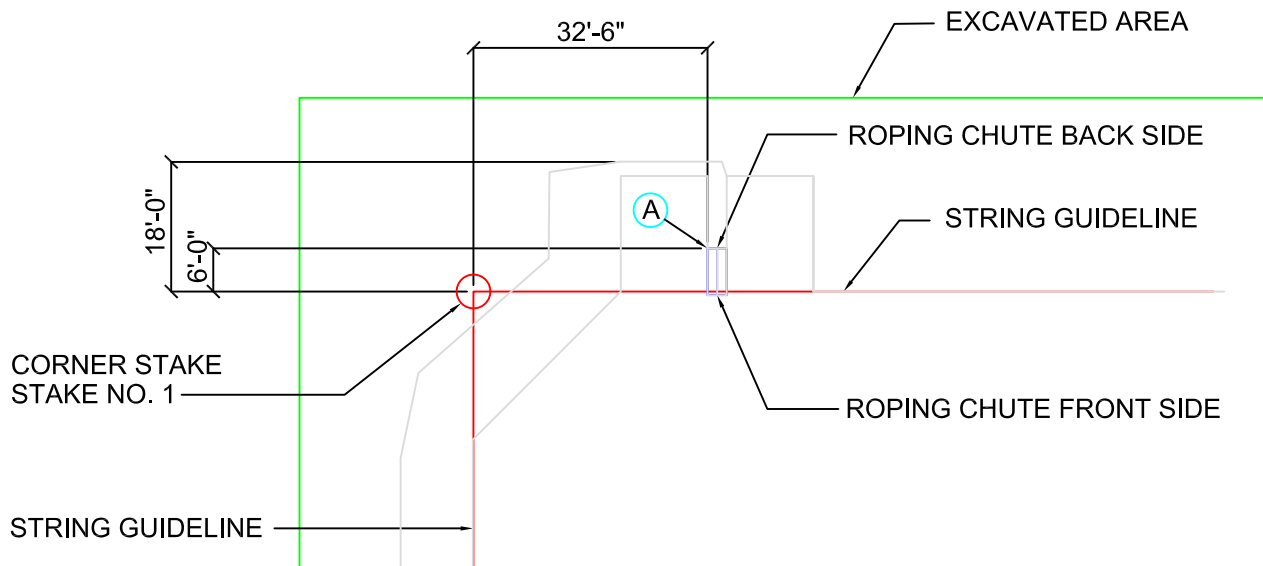

CHUTE TO LEADUP CONNECTION

- 1.) Place 26.5" STABILIZER BAR (B) on ground and place LEADUP Leg over the STABILIZER BAR for support.
- 2.) Slide 5/8" x 5" U-BARS into CHUTE and LEADUP spools.
- 3.) Place 26.5" STABILIZER BAR (B) over top LEADUP Leg for support.

NOTE: ROPING CHUTE LEFT SIDE AND LEADUP PANEL SHOULD LINE UP WITH ONE ANOTHER.

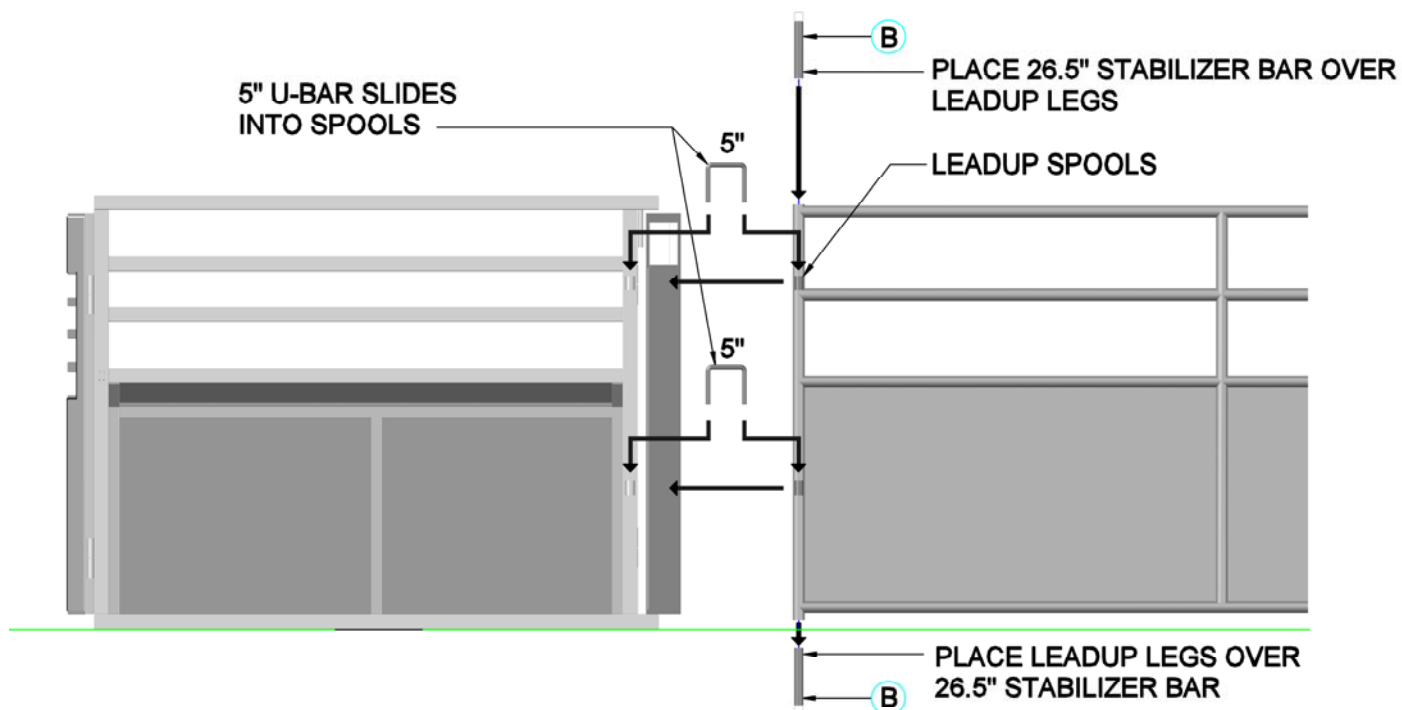

ROPING CHUTE LEFT SIDE

LEADUP PANEL

STANDING BEHIND THE CHUTE
LEADUP TO LEFT SIDE CHUTE CONNECTION w/ 5" U-BARS

CHUTE TO LEADUP CONNECTION

- 1.) Place LEADUP Leg over the STABILIZER (B) BAR for support.
- 2.) Slide 5/8" x 8" BENT U-BARS into CHUTE and LEADUP spools.
- 3.) Place 26.5" STABILIZER BAR (B) over top LEADUP Leg for support.

NOTE: ROPING CHUTE LEFT SIDE AND LEADUP PANEL SHOULD LINE UP WITH ONE ANOTHER.

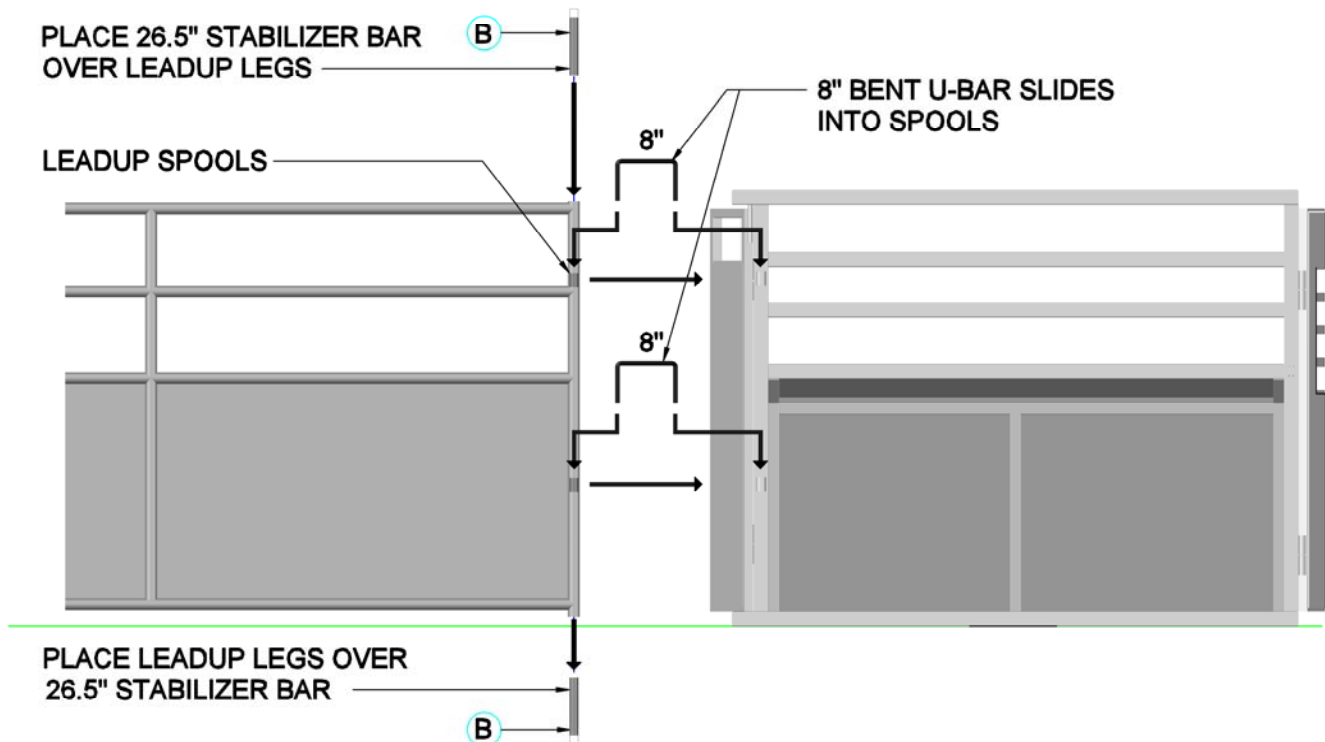

LEADUP PANEL

ROPING CHUTE RIGHT SIDE

STANDING BEHIND THE CHUTE
LEADUP TO RIGHT SIDE CHUTE CONNECTION w/ 8" U-BARS

CHUTE TO LEADUP CONNECTION

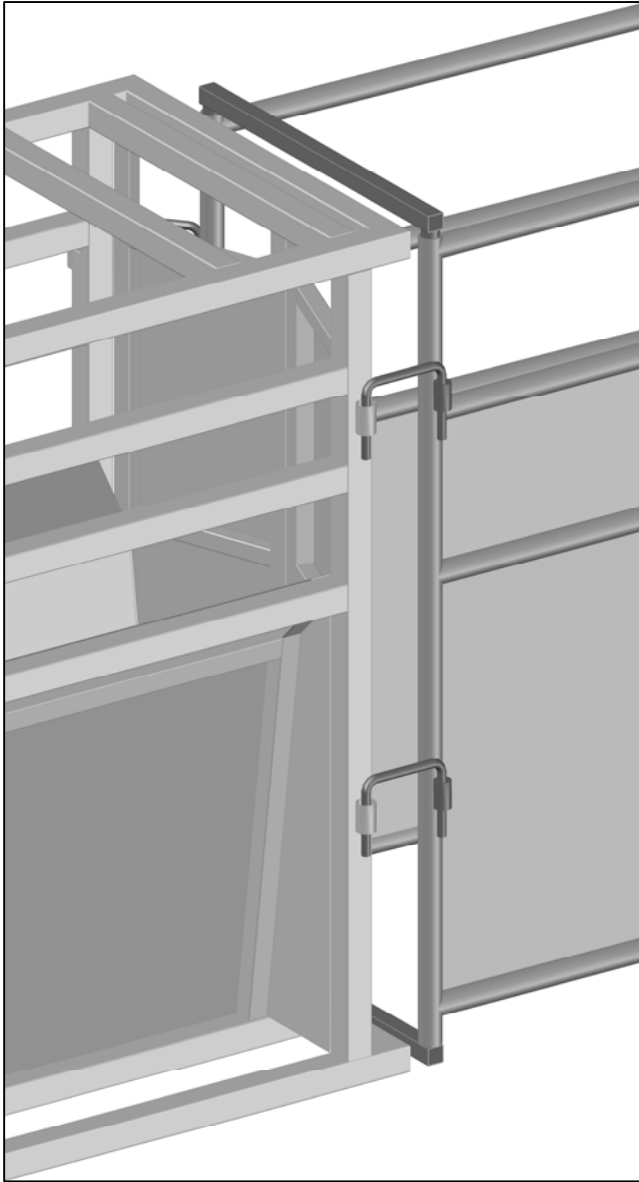

ROPING CHUTE LEFT SIDE
(5/8" x 5" U-BAR)

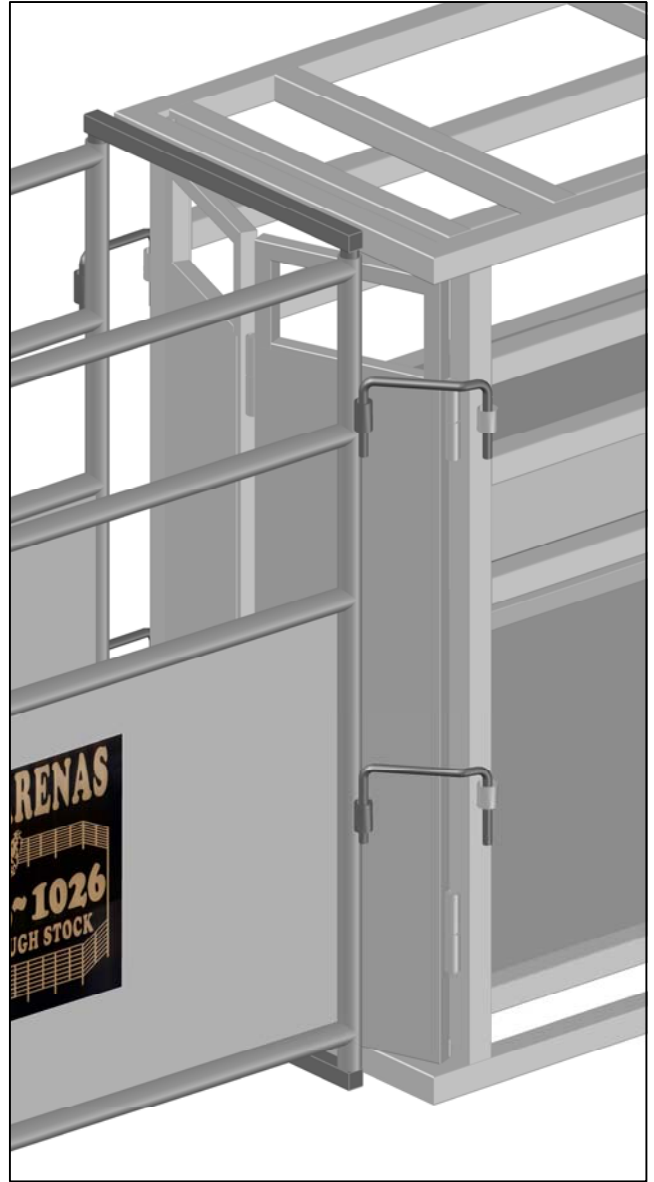

ROPING CHUTE RIGHT SIDE
(5/8" x 8" BENT U-BAR)

STANDING BEHIND CHUTE
LEFT AND RIGHT CHUTE TO LEADUP U-BAR CONNECTIONS

LEADUP TO 2' FT PANEL CONNECTION (ROPING CHUTE LEFT SIDE)

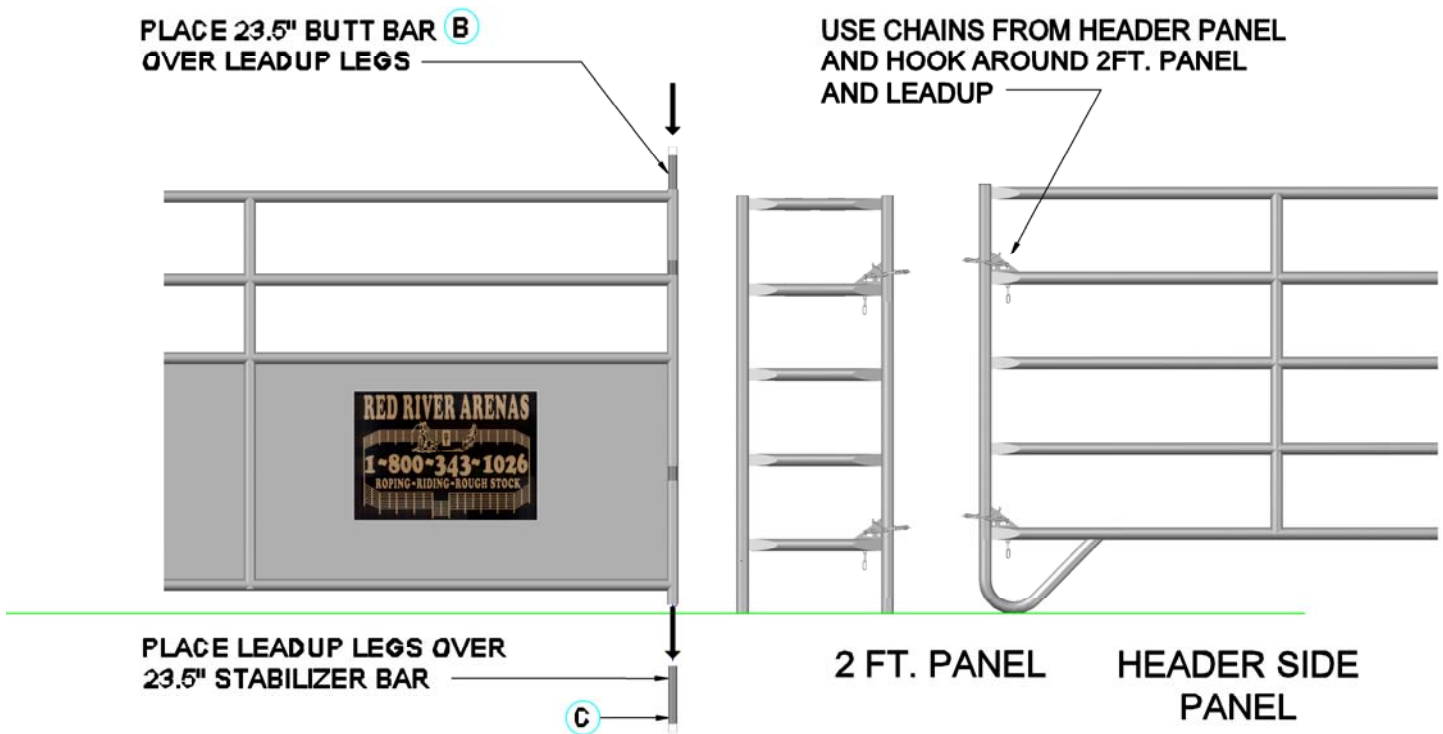

LEADUP PANEL

STANDING BEHIND CHUTE
LEFT SIDE LEADUP TO PANEL CONNECTION

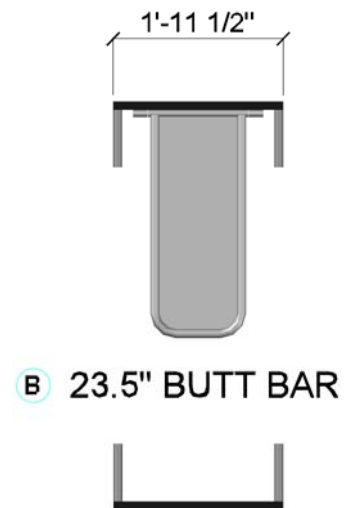

LEADUP TO PANEL CONNECTION (ROPING CHUTE RIGHT SIDE)

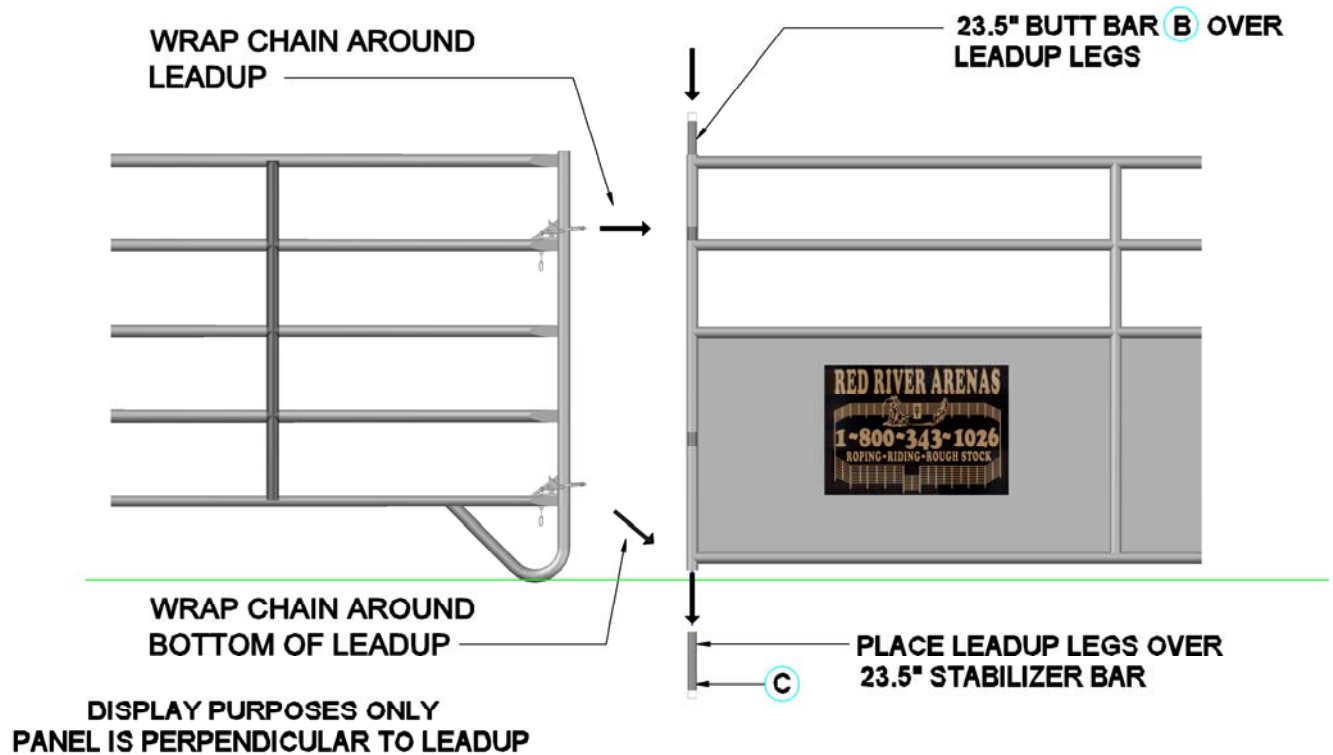

PANEL

LEADUP PANEL

STANDING BEHIND CHUTE
RIGHT SIDE LEADUP TO PANEL CONNECTION

PANEL TO PANEL CONNECTION

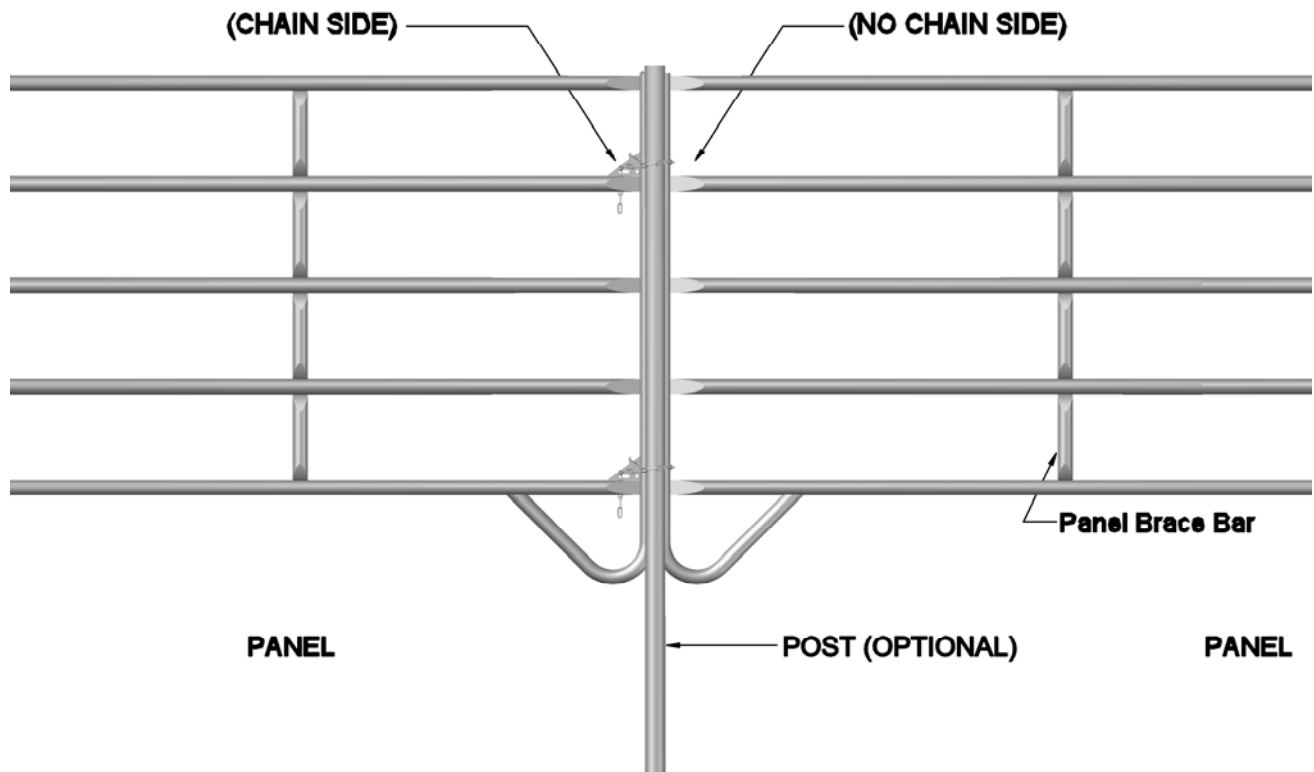

NOTE: WHEN PLACING PANELS - THE PANEL BRACE BAR FACES INSIDE OF THE ARENA AREA AND POST ARE OUTSIDE OF ARENA

PANEL TO PANEL CONNECTION

PANEL TO STRIPPING CHUTE CONNECTION w/ POST S1

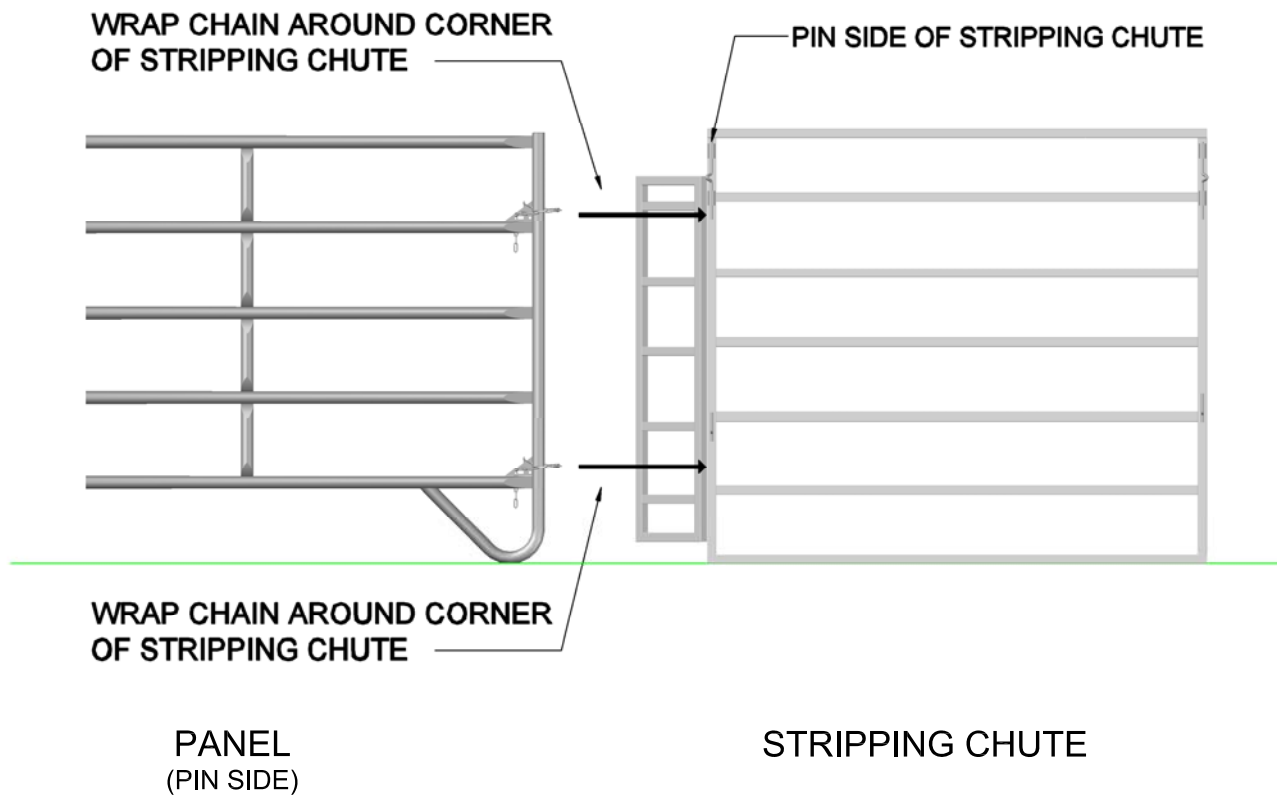

PANEL TO STRIPING CHUTE CONNECTION w/ POST S1