

RED RIVER ARENAS.com

“Spend Less, Get More!”

800-343-1026

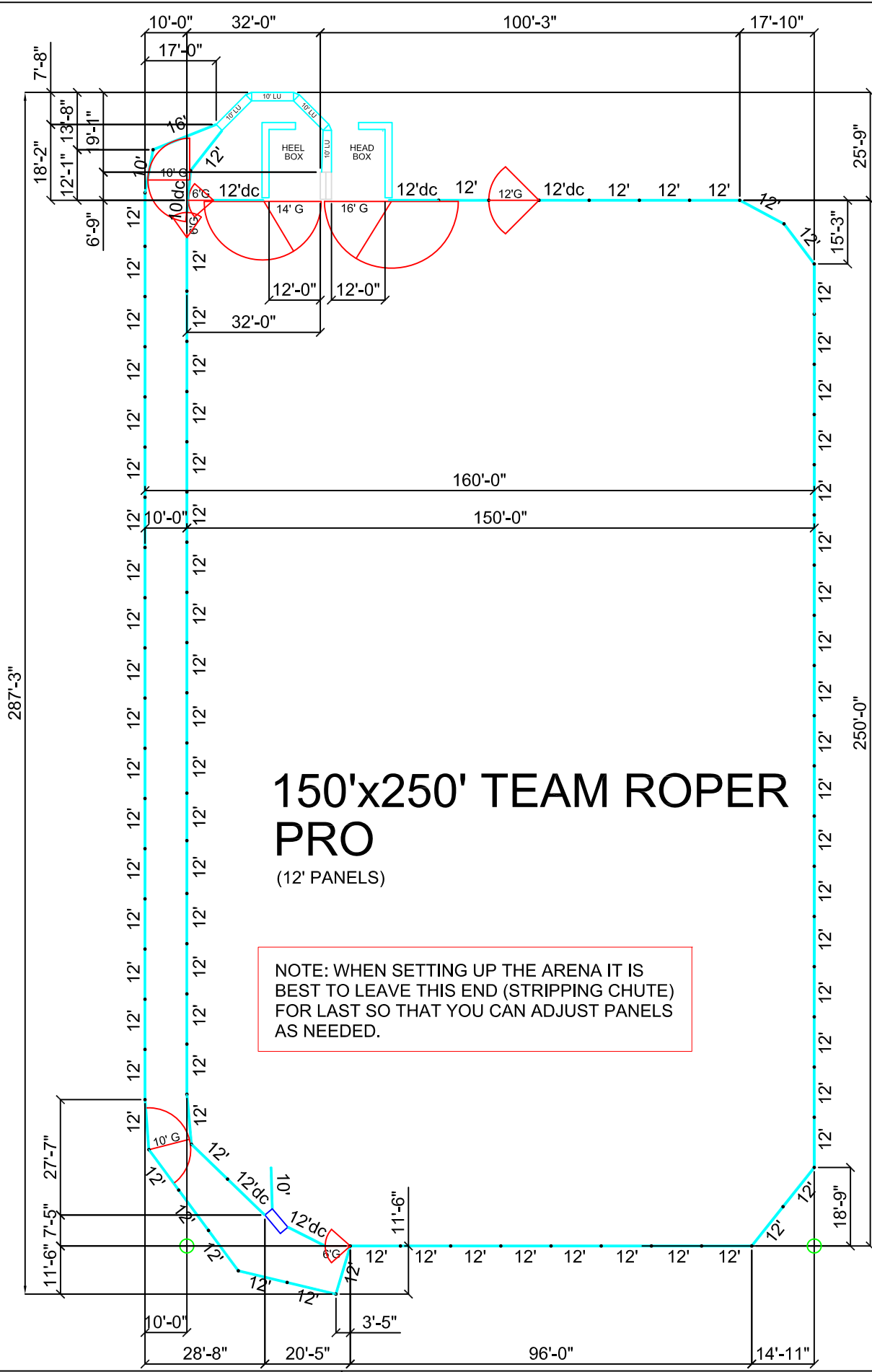

150'x250' TEAM ROPER PRO

(12' PANELS)

NOTE: WHEN SETTING UP THE ARENA IT IS BEST TO LEAVE THIS END (STRIPPING CHUTE) FOR LAST SO THAT YOU CAN ADJUST PANELS AS NEEDED.

This drawing is the property of RedRiverArenas.com. RedRiverArenas does not authorize the reproduction or conveyance of any information contained herein without prior written permission.

DIMENSION LAYOUT

150' X 250' TEAM ROPER PRO EXCAVATION AREA

MINIMUM EXCAVATION AREA IS 160'-0" BY 287'-3"

- 1 Start by staking out the Arena Area (150'-0" by 250'-8") to use as a guideline for panels.

NOTE: IF EXCAVATION EXCEEDS THE GIVEN DIMENSIONS OWNER
WILL NEED TO COMPENSATE ACCORDINGLY

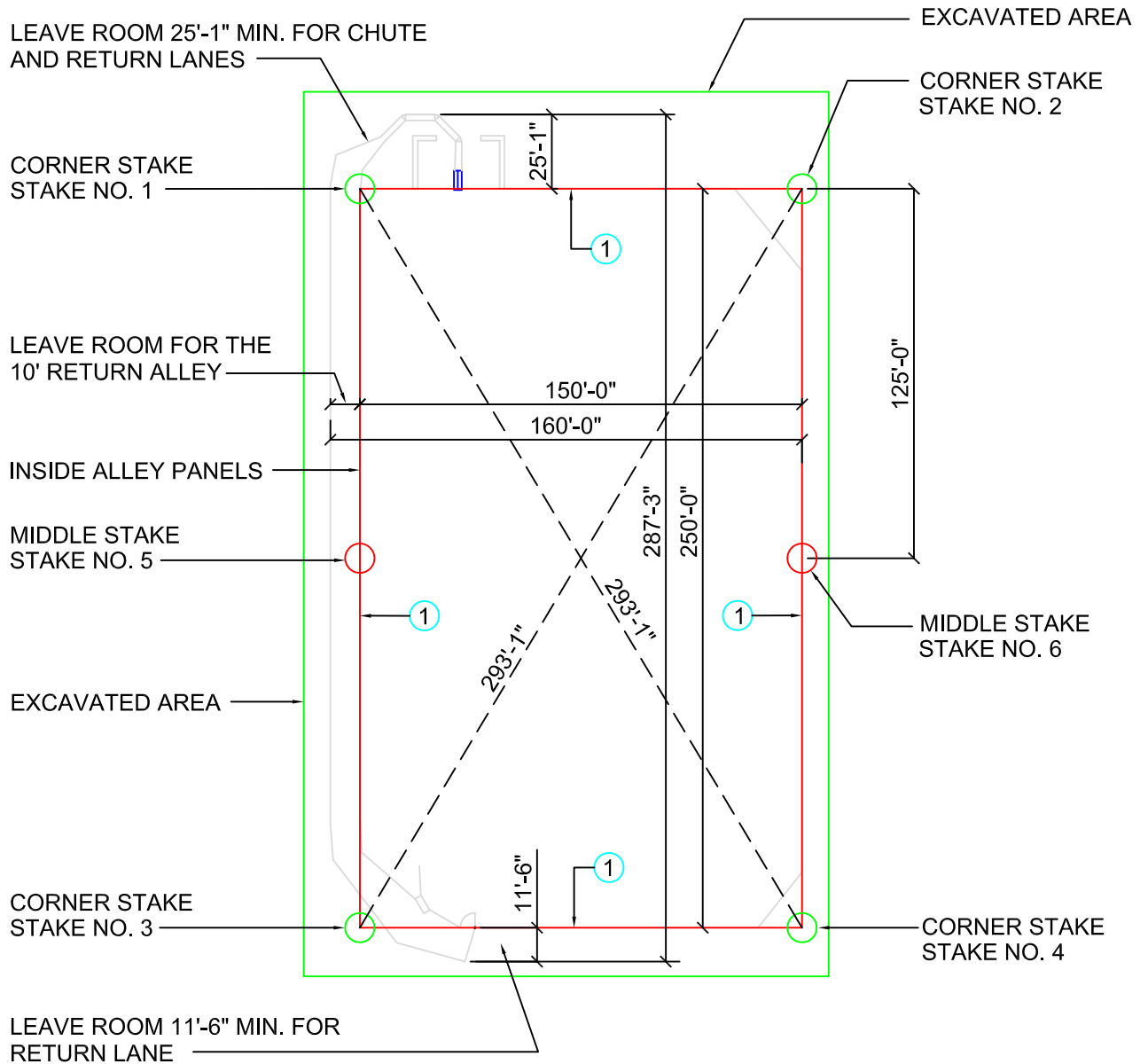

This drawing is the property of RedRiverArenas.com
RedRiverArenas does not authorize the reproduction or
conveyance of any information contained herein
without prior written permission.

EXCAVATION

REDRIVERARENAS.COM

PHONE : 1-325-625-1900

TUBE-S12-05-WC

150' X 250' TEAM ROPER PRO ROPING CHUTE LOCATION

② Position the BACK Corner (A) of the Roping Chute at the dimension shown below:

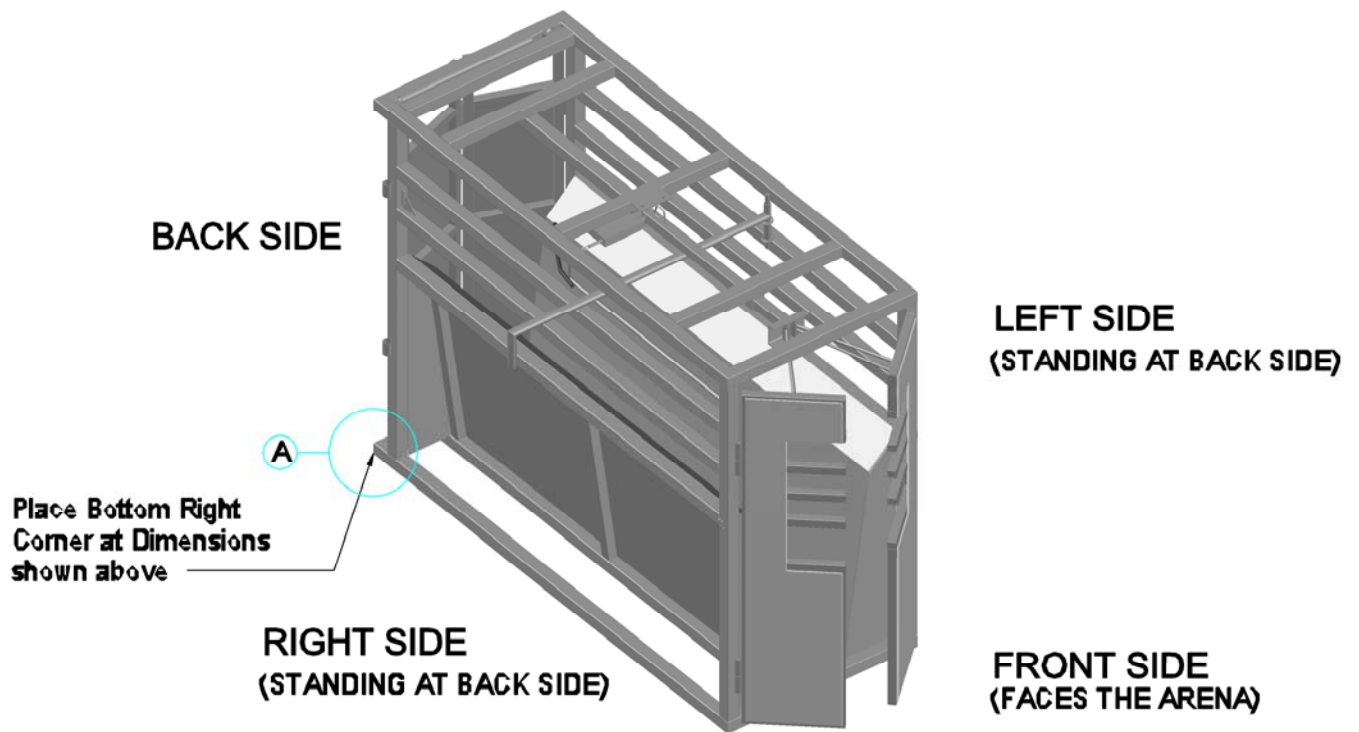
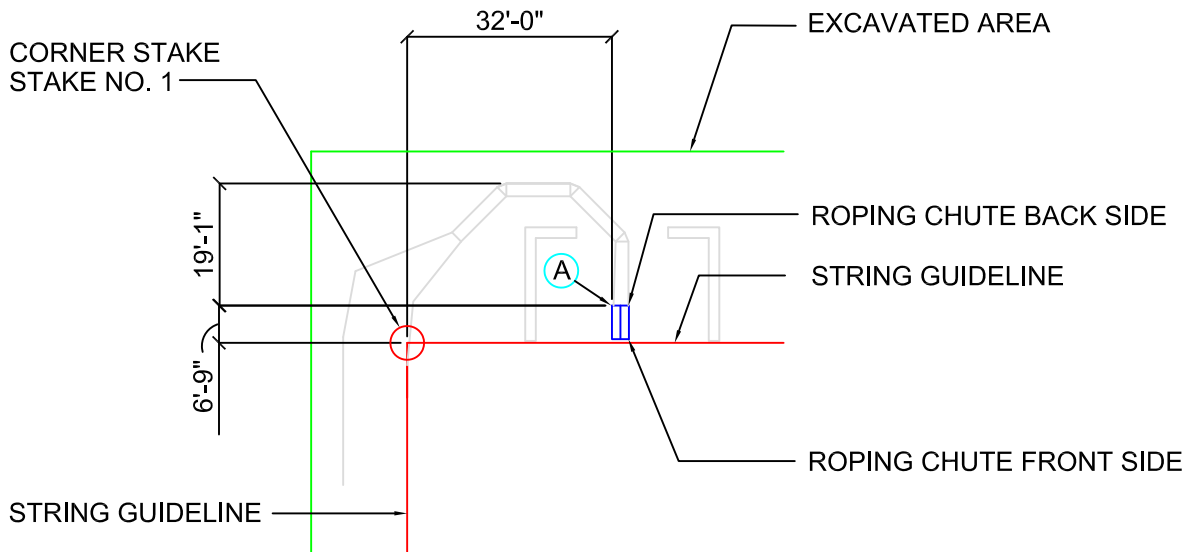

This drawing is the property of RedRiverArenas.com
RedRiverArenas does not authorize the reproduction or
conveyance of any information contained herein
without prior written permission.

CHUTE LOCATION

REDRIVERARENAS.COM

PHONE : 1-325-625-1900

TUBE-S12-05-WC

LEADUP TO CHUTE CONNECTION

- 1.) Place 26.5" STABILIZER BAR (B) on ground and place LEADUP Leg over the STABILIZER BAR for support.
- 2.) Slide 5/8" x 5" U-BARS into CHUTE and LEADUP spools.
- 3.) Place 26.5" STABILIZER BAR (B) over top LEADUP Leg for support.

NOTE: ROPING CHUTE LEFT SIDE AND LEADUP PANEL SHOULD LINE UP WITH ONE ANOTHER.

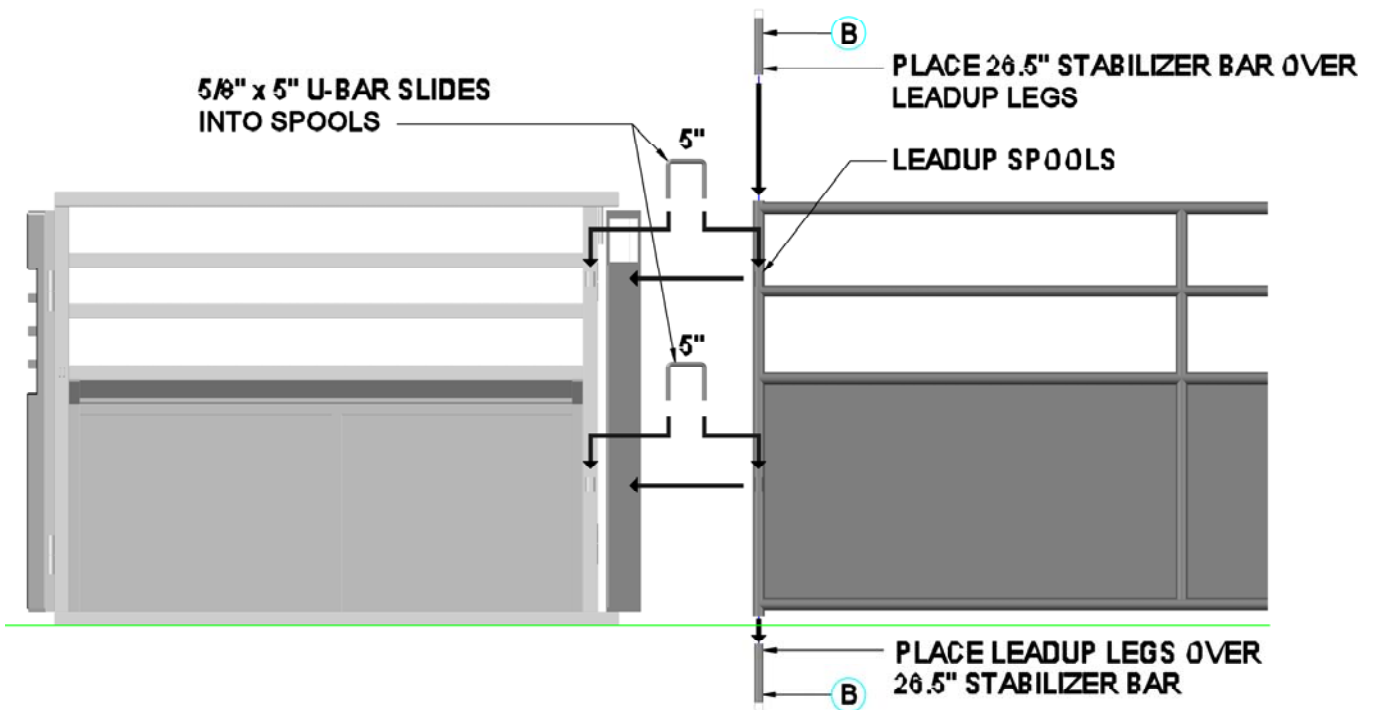

ROPING CHUTE LEFT SIDE

LEADUP PANEL

STANDING BEHIND THE CHUTE
LEADUP TO LEFT SIDE CHUTE CONNECTION w/ 5" U-BARS

CHUTE TO LEADUP CONNECTION

- 1.) Place LEADUP Leg over the STABILIZER (B) BAR for support.
- 2.) Slide 5/8" x 8" BENT U-BARS into CHUTE and LEADUP spools.
- 3.) Place 26.5" STABILIZER BAR (B) over top LEADUP Leg for support.

NOTE: ROPING CHUTE LEFT SIDE AND LEADUP PANEL SHOULD LINE UP WITH ONE ANOTHER.

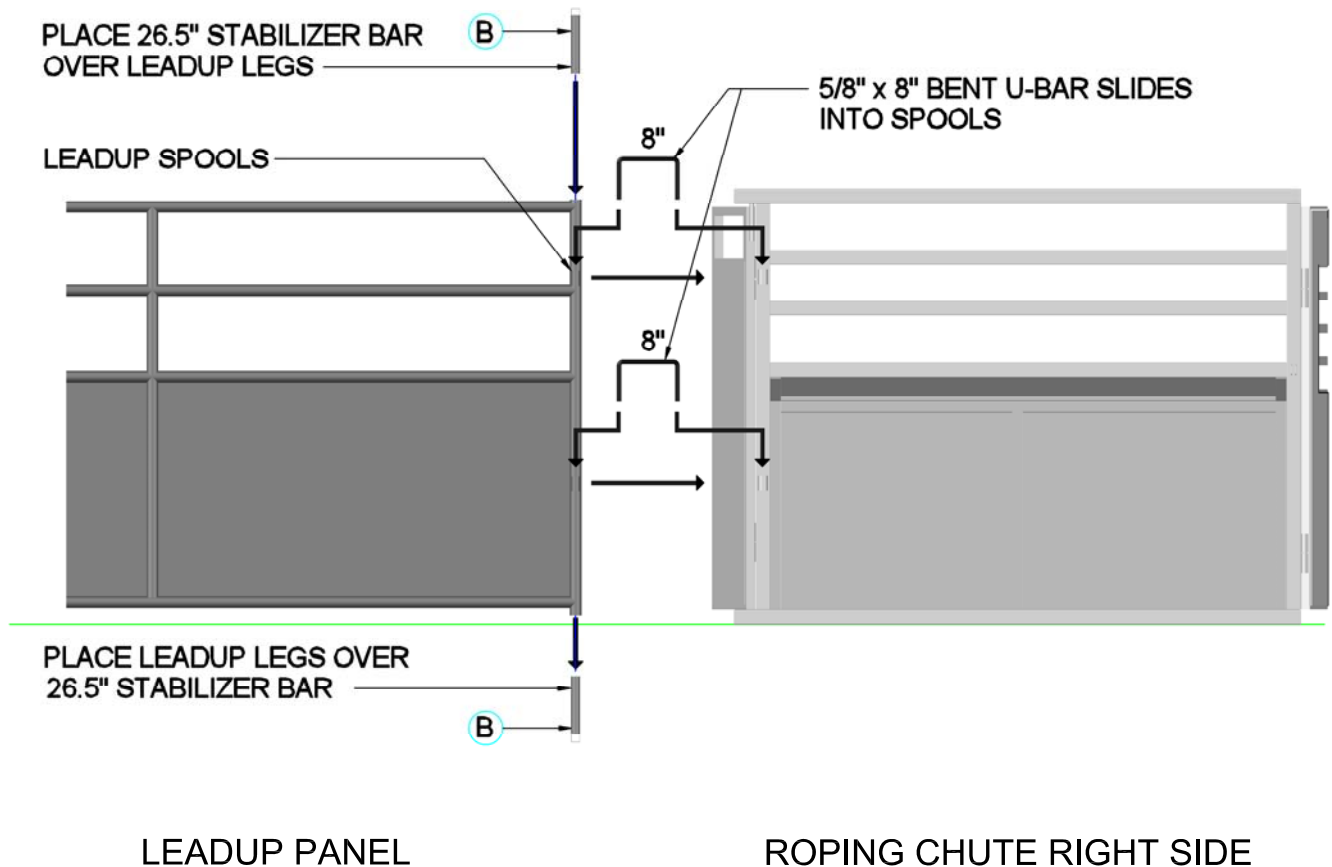

STANDING BEHIND THE CHUTE
LEADUP TO RIGHT SIDE CHUTE CONNECTION w/ 8" U-BARS

LEADUP TO CHUTE CONNECTION

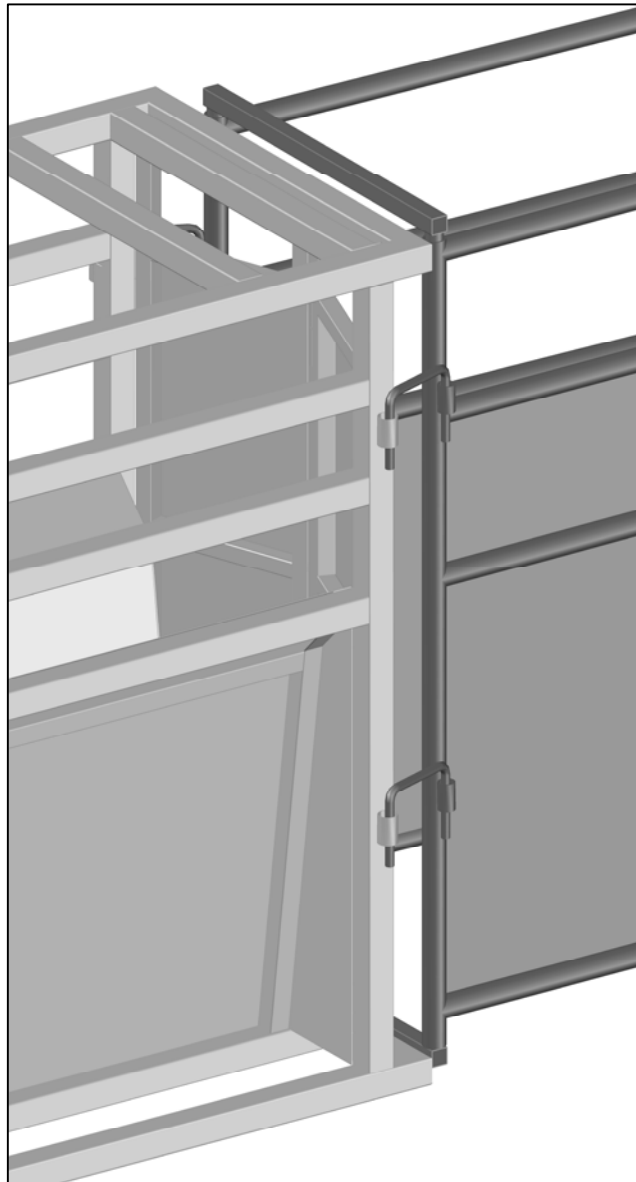

ROPING CHUTE LEFT SIDE
(5/8" x 5" U-BAR)

ROPING CHUTE RIGHT SIDE
(5/8" x 5" BENT U-BAR)

STANDING BEHIND CHUTE
LEFT AND RIGHT LEADUP TO CHUTE U-BAR CONNECTIONS

This drawing is the property of RedRiverArenas.com
RedRiverArenas does not authorize the reproduction or
conveyance of any information contained herein
without prior written permission.

LEADUP TO CHUTE RIGHT SIDE

REDRIVERARENAS.COM

PHONE : 1-325-625-1900

TUBE-S12-05-WC

10' LEADUP TO 2' FT PANEL (ROPING CHUTE LEFT SIDE)

PLACE 23.5" BUTT BAR **B**
OVER LEADUP LEGS

LEADUP SPOOLS

3" U-BAR SLIDES
INTO SPOOLS

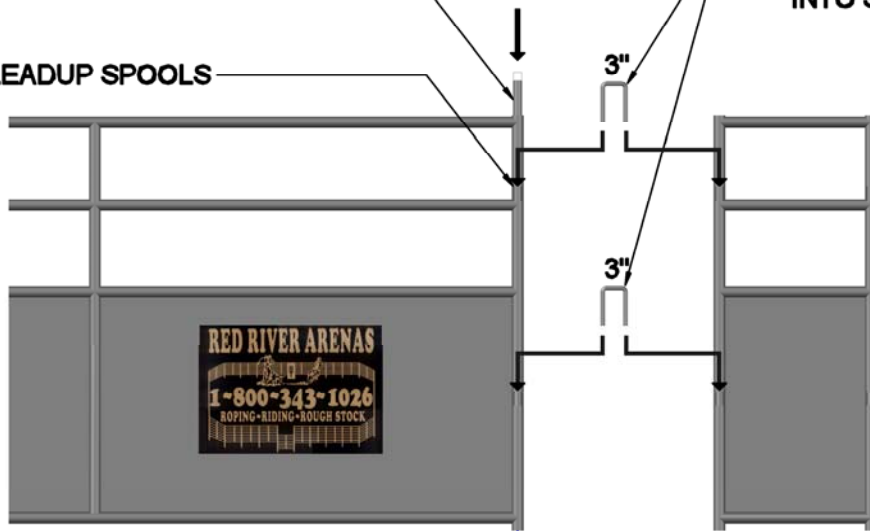

PLACE LEADUP LEGS OVER
23.5" STABILIZER BAR

C

LEADUP PANEL

2 FT. LEADUP

STANDING BEHIND CHUTE
LEFT SIDE LEADUP TO 2' FT. LEADUP CONNECTION

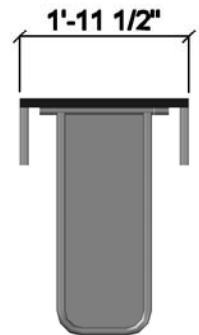

B 23.5" BUTT BAR



C 23.5" STABILIZER BAR

PANEL TO LEADUP CONNECTION (END OF LEADUPS)

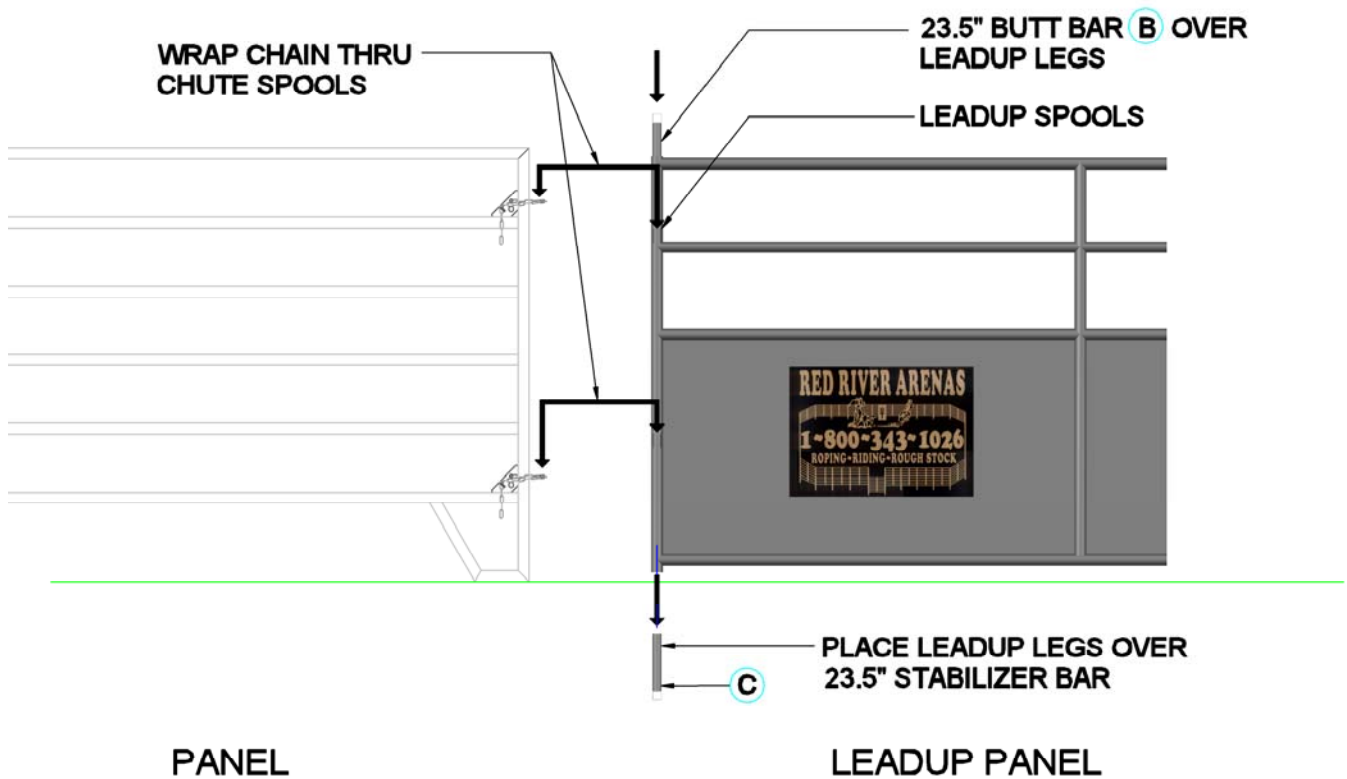

PANEL TO END LEADUPS CONNECTION

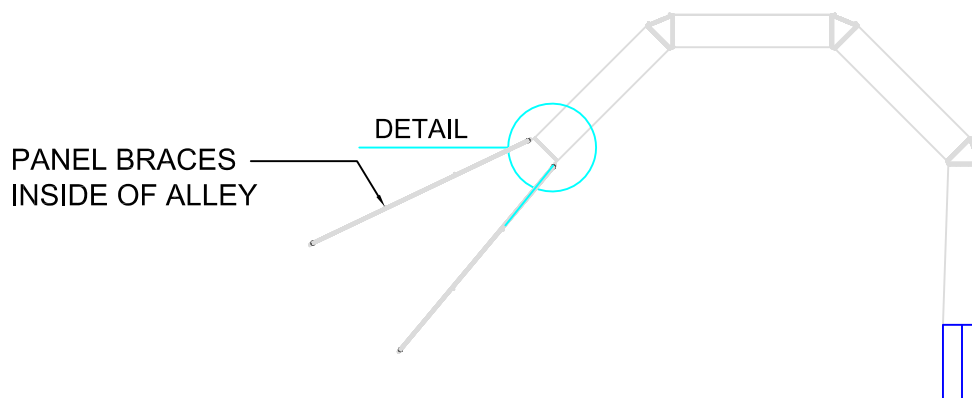

This drawing is the property of RedRiverArenas.com. RedRiverArenas does not authorize the reproduction or conveyance of any information contained herein without prior written permission.

PANELS TO END LEADUPS CONNECTION

REDRIVERARENAS.COM

PHONE : 1-325-625-1900

TUBE-S12-05-WC

PANEL TO PANEL CONNECTION

(CHAIN CONNECTION)

PANEL CHAIN CONNECTION

1. USING THE MARK(S) YOU MAKE WITH THE STRING. ALIGN AND CONNECT ONE PANEL AT A TIME.
2. WRAP CHAIN AROUND PANEL LEG AND ATTACH TO CHAIN KEEPER.
3. PANL SHOULD NOW BE CONNECTED. YOU CAN ADJUST ONE PANEL 90° FOR BALANCE.

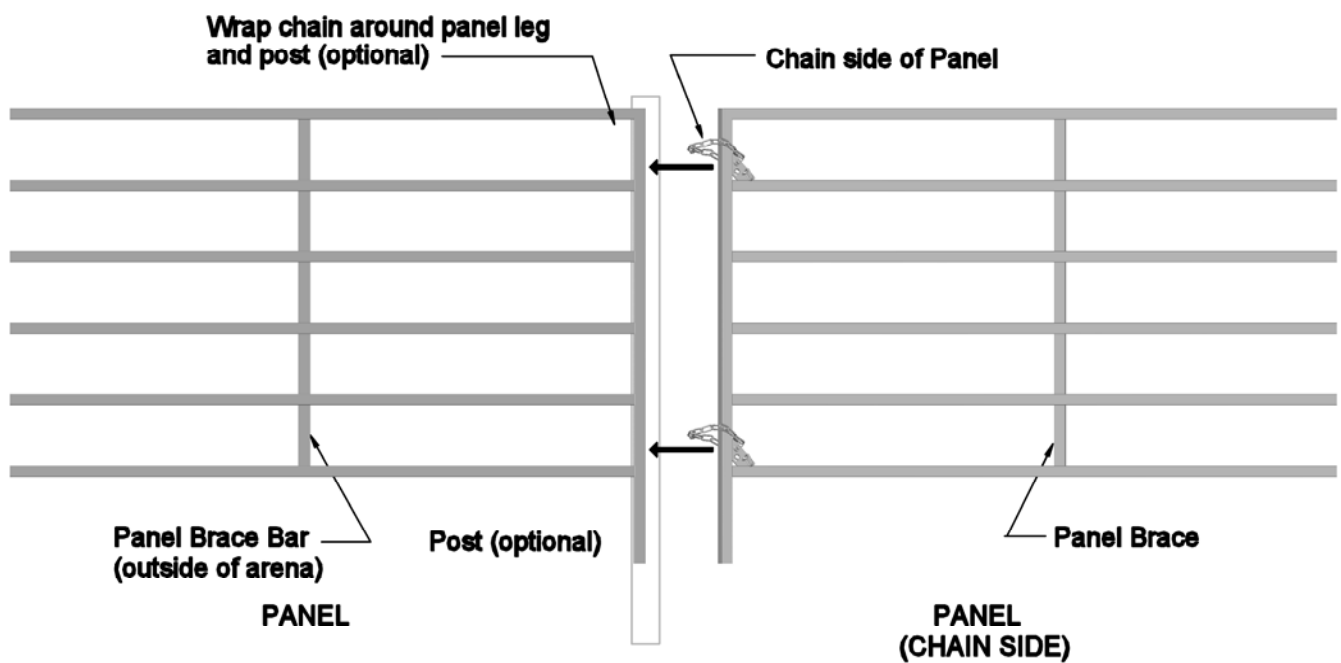

PANEL TO PANEL CONNECTION WITH CHAINS

PANEL TO STRIPPING CHUTE CONNECTION

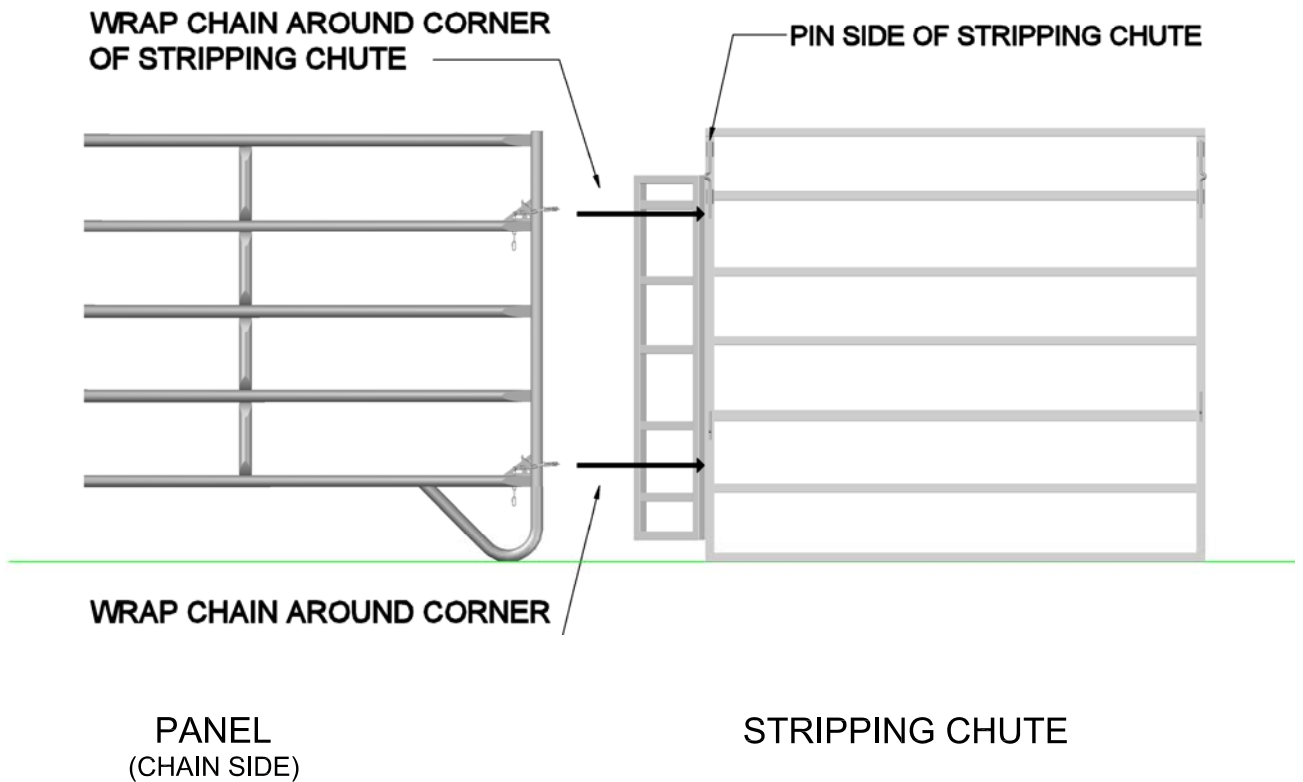

PANEL TO STRIPING CHUTE CONNECTION